

aerospace
 climate control
 electromechanical
filtration
 fluid & gas handling
 hydraulics
 pneumatics
 process control
 sealing & shielding

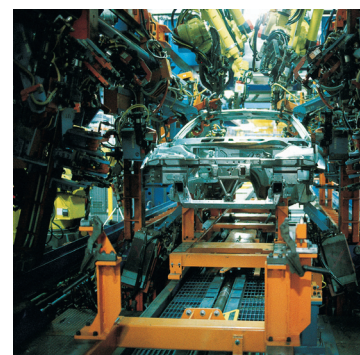

15/40/80CN Series

Coreless Medium Pressure Filters



ENGINEERING YOUR SUCCESS.

15/40/80CN Series

Applications

- Compressor Lube Oil
- Off-line Filter Loops
- Machine Tools (Automotive Standard)
- Hydrostatic Drive Charge Pumps
- Mobile Equipment
- Pilot Lines For Servo Controls
- Oil Patch Drilling Equipment
- Injection Molding

This partial list of applications for Parker “CN” series filters has a common factor, the need for an economical, medium pressure range filter with excellent fatigue pressure ratings. Prior to the availability of the “CN” filter, applications such as those listed were restricted by limitations of a spin-on can, or forced into the higher cost range of high pressure filters.

The “CN” series fills this gap, and now with the newly increased fatigue rating from 550 to 800 psi, the applications are expanded.

Ecoglass III Replacement Elements

Ecoglass III represents the merging of high performance filtration technology with environmentally conscious engineering. The Ecoglass III line of replacement elements feature 100% non-metallic construction. The design reduces solid waste and minimizes disposal costs for industry. The non-metallic construction means lightweight elements (60% less weight) for easier servicing.

The Ecoglass III elements utilize the same proprietary media design as our Microglass III line of replacement elements.

With Ecoglass III, a reusable core is installed into the filter housing and remains in service throughout the life of the assembly.



Features	Advantages	Benefits
<ul style="list-style-type: none"> . 800 psi fatigue rating (eight times that of a spin-on) 	<ul style="list-style-type: none"> . Ability to provide reliable service under tough cyclic operating conditions . Can be utilized in applications where high pressure filters may have been only option 	<ul style="list-style-type: none"> . Reduced downtime due to premature filter failures . Reduced costs, better “fit” for the application
<ul style="list-style-type: none"> . Diametral (side) seal between head and bowl . Dust Seal 	<ul style="list-style-type: none"> . Proven reliability in cyclic applications . Reduced importance of bowl torque . Prevents contamination from building up on bowl / head threads 	<ul style="list-style-type: none"> . No downtime, no leaks . Performs with “real world” service . Easier service, no galling
<ul style="list-style-type: none"> . Cast aluminum head 	<ul style="list-style-type: none"> . Low profile, lightweight and durable 	<ul style="list-style-type: none"> . Less weight, smaller envelop and cleaner appearance
<ul style="list-style-type: none"> . Standard Ecoglass III elements 	<ul style="list-style-type: none"> . Multi-layered design produced high capacity and efficiency . Reduces pleat bunching, keeps performance consistent 	<ul style="list-style-type: none"> . Great performance value . Reliable performance throughout element life . Reduces downtime, maximizes element life
<ul style="list-style-type: none"> . Complete performance data disclosure 	<ul style="list-style-type: none"> . All pertinent information is provided in an easy-to-compare format 	<ul style="list-style-type: none"> . No hidden deficiencies . Easy selection of proper filtration
<ul style="list-style-type: none"> . Visual, electrical or electrical/visual indicators available 	<ul style="list-style-type: none"> . Check element condition at a glance . Right style for the application 	<ul style="list-style-type: none"> . Optimize element life, prevent bypassing . Matches your system electrical connections

15/40/80CN Series

Features

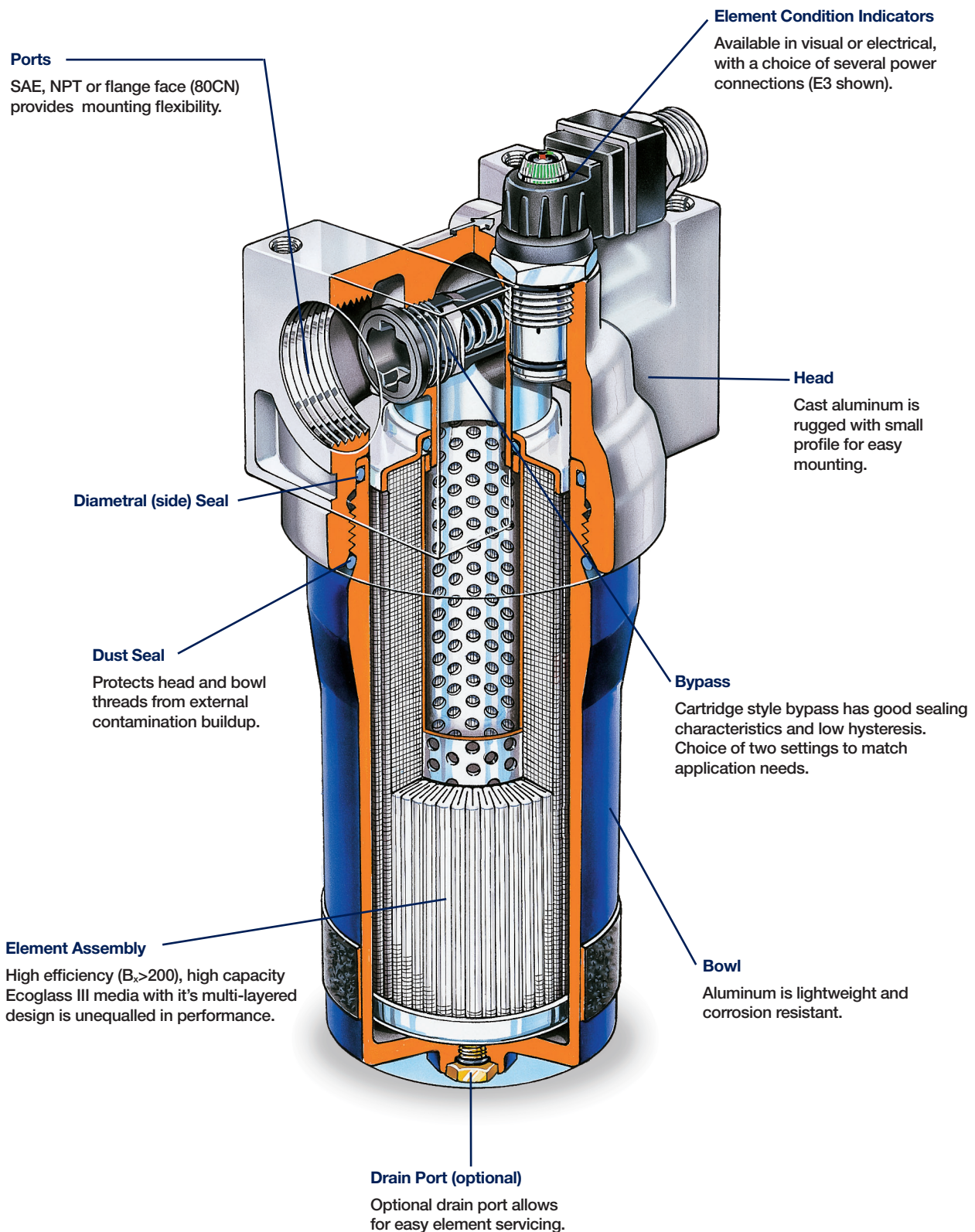

15CN Series

15CN-1 Element Performance

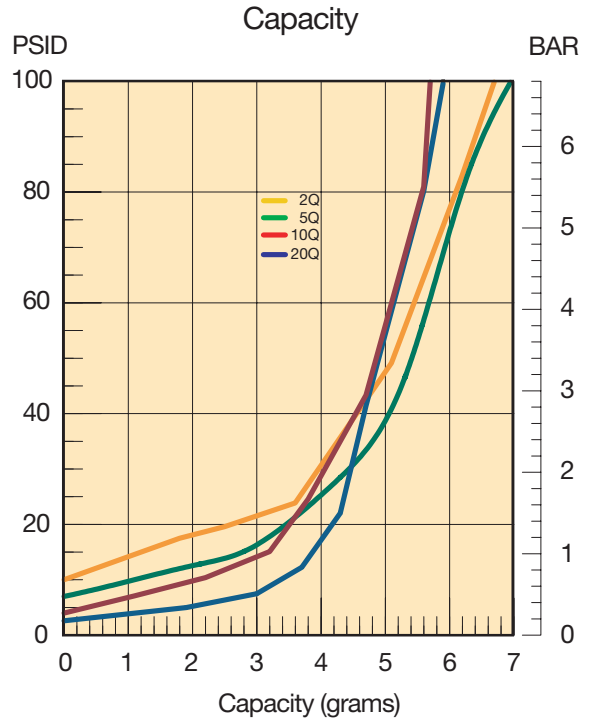
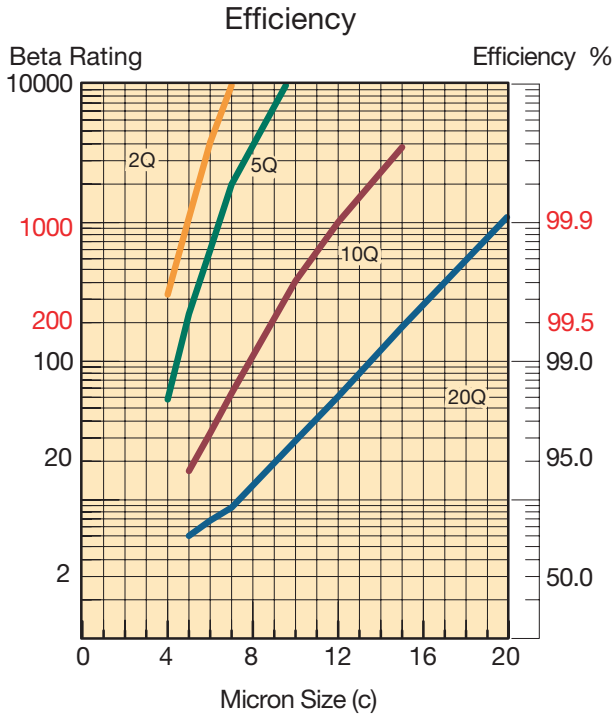

Results typical from Multi-pass tests run per test standard ISO 16889 @ 10 gpm to 100 psid terminal - 10 mg/L BUGL
 Refer to Appendix on pages 264-265 for relationship to test standard ISO 4572.

Flow vs. Pressure Loss

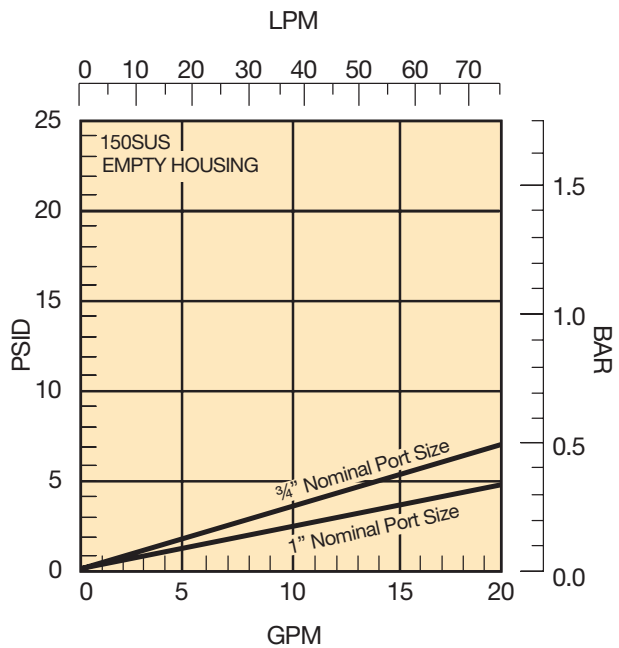
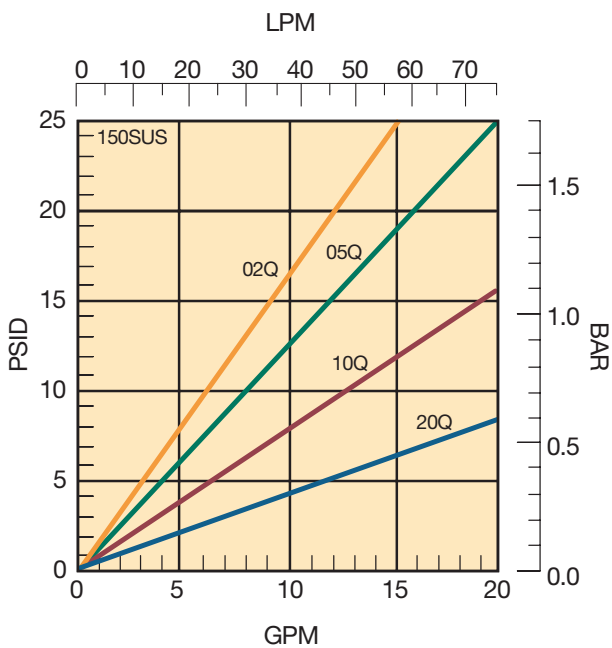

15CN Series

15CN-2 Element Performance

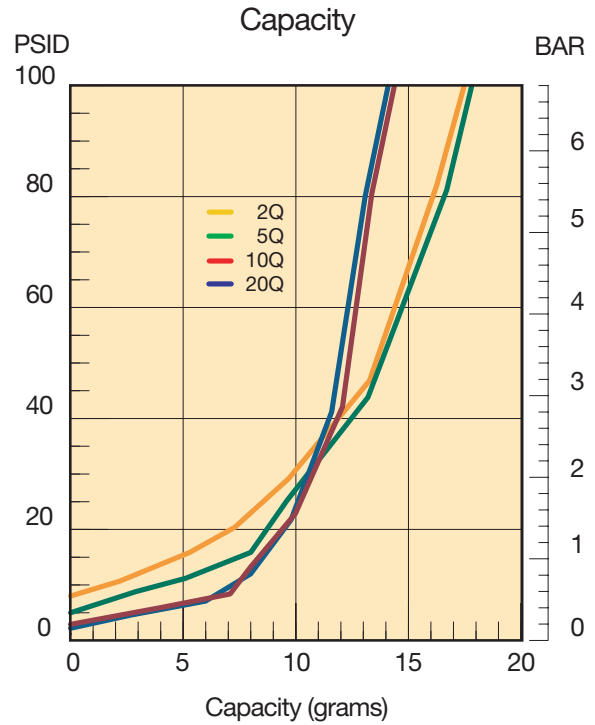
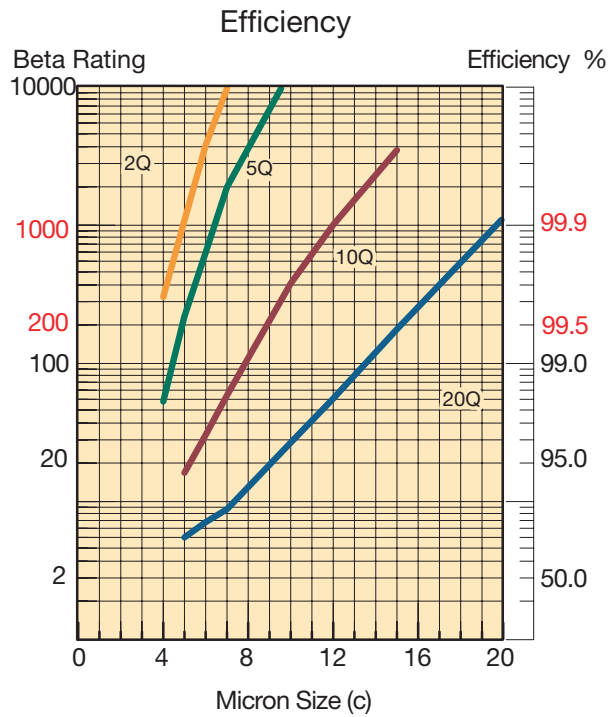

Results typical from Multi-pass tests run per test standard ISO 16889 @ 15 gpm to 100 psid terminal - 10 mg/L BUGL
 Refer to Appendix on pages 264-265 for relationship to test standard ISO 4572.

Flow vs. Pressure Loss

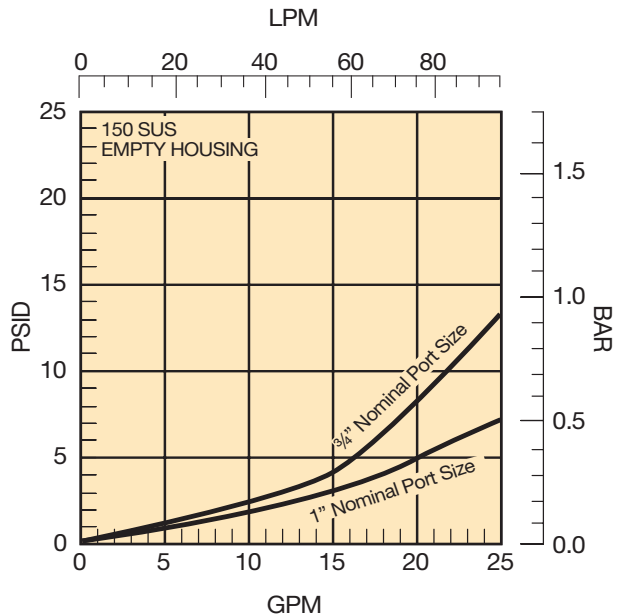
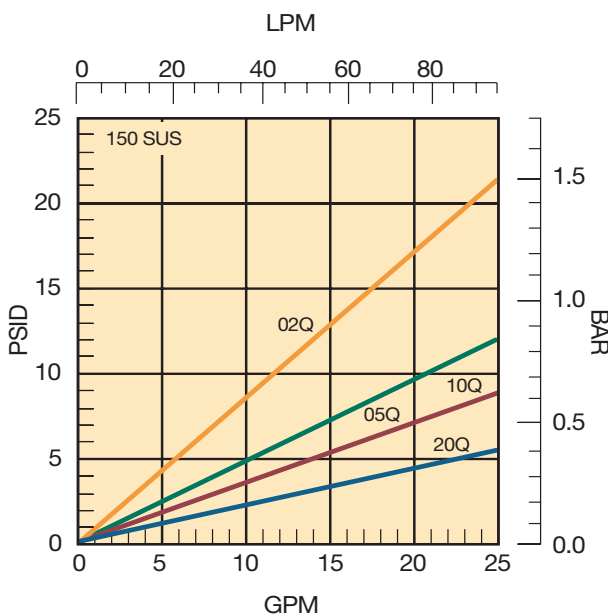

40CN Series

40CN-1 Element Performance

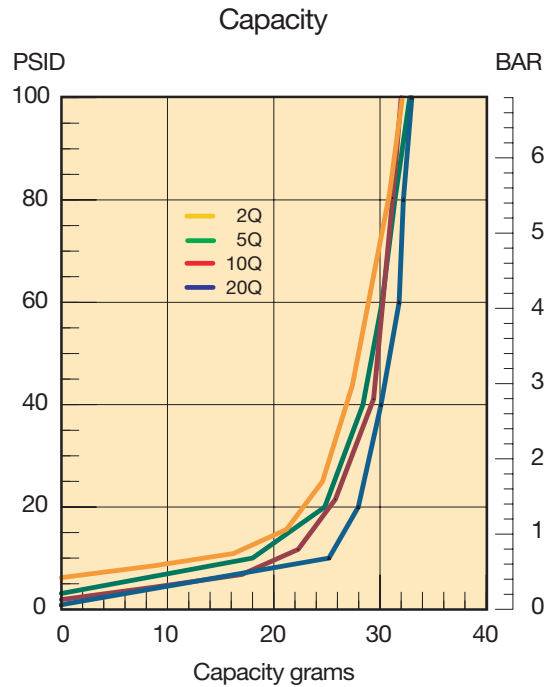
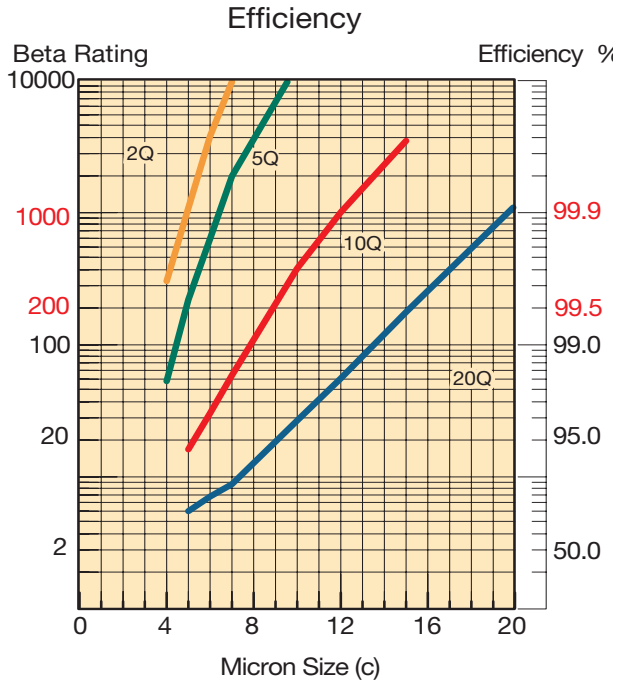

Results typical from Multi-pass tests run per test standard ISO 16889 @ 15 gpm to 100 psid terminal - 10 mg/L BUGL
 Refer to Appendix on pages 264-265 for relationship to test standard ISO 4572.

Flow vs. Pressure Loss

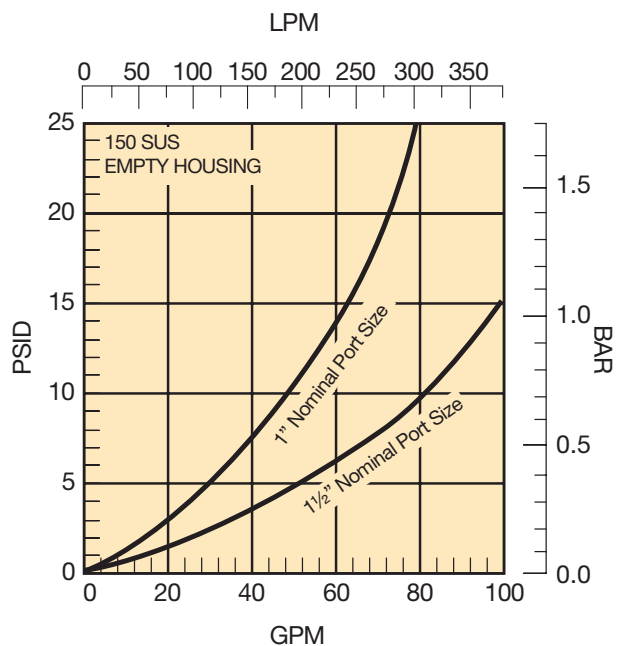
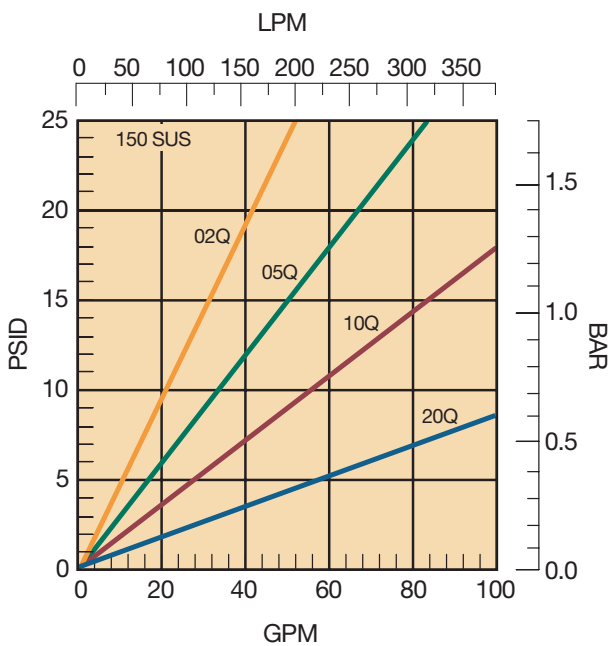

40CN Series

40CN-2 Element Performance

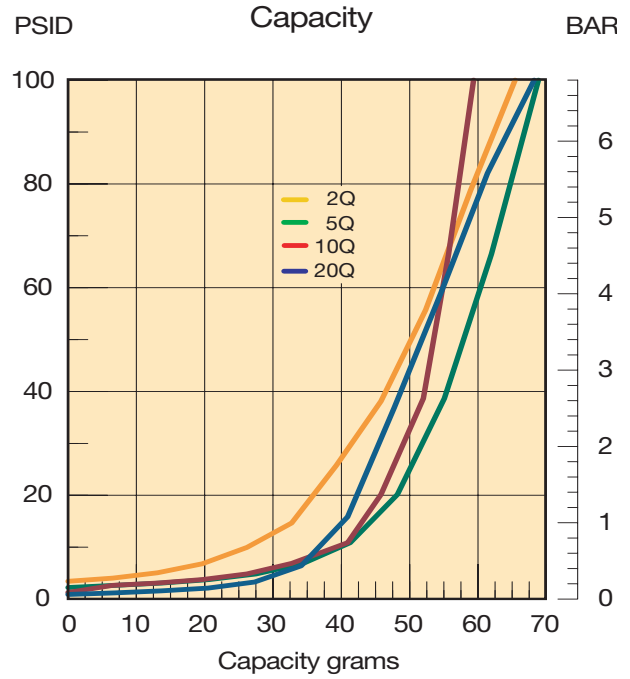
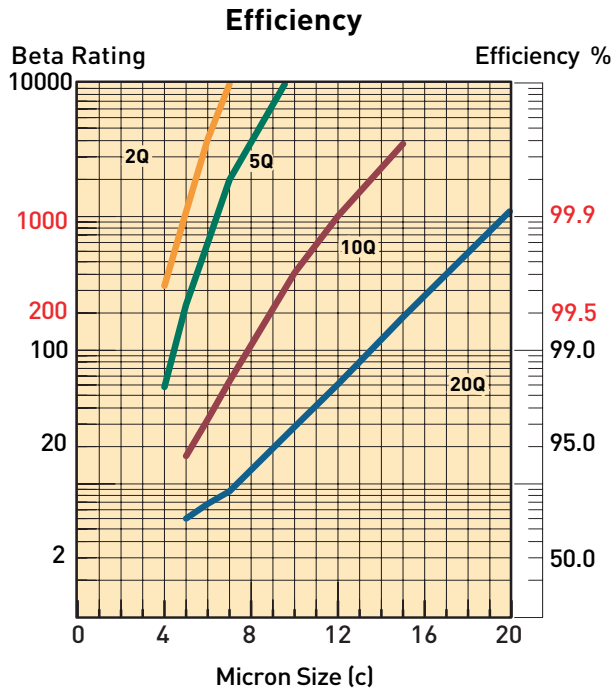

Results typical from Multi-pass tests run per test standard ISO 16889 @ 30 gpm to 100 psid terminal - 10 mg/L BUGL
 Refer to Appendix on pages 264-265 for relationship to test standard ISO 4572.

Flow vs. Pressure Loss

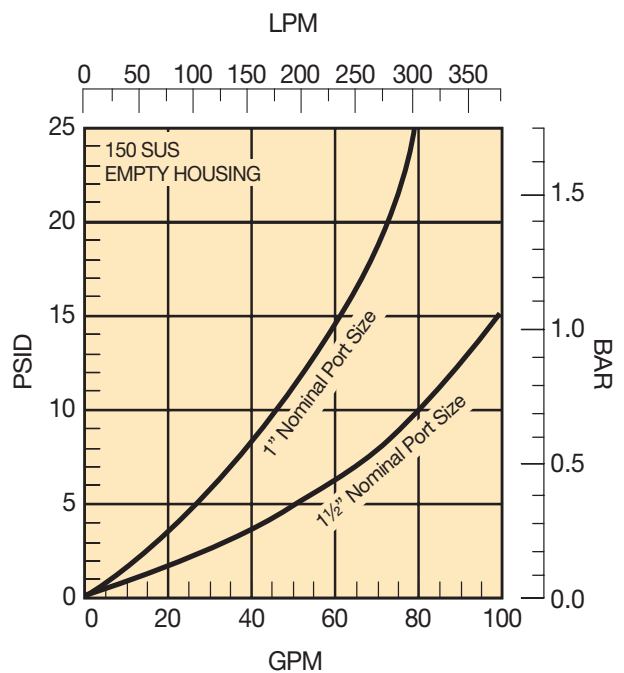
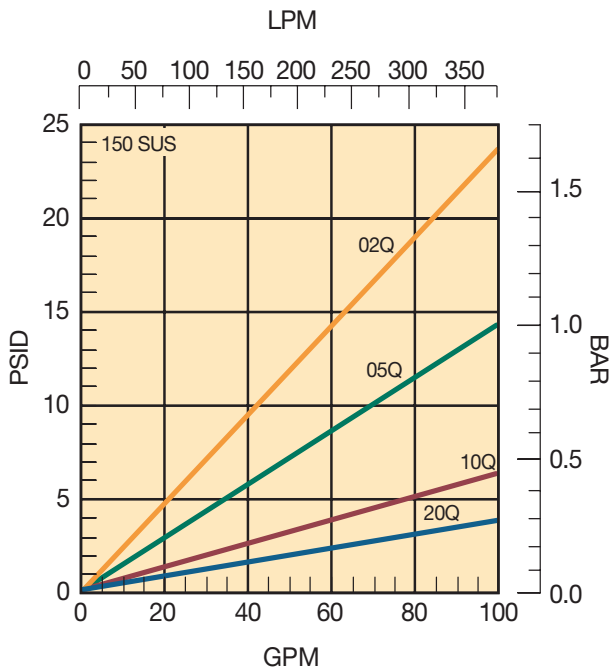

40CN Series

40CN-3 Element Performance

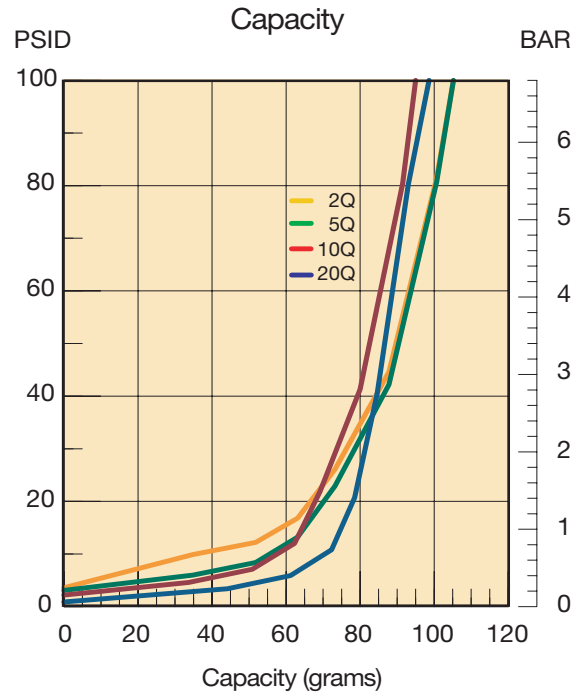
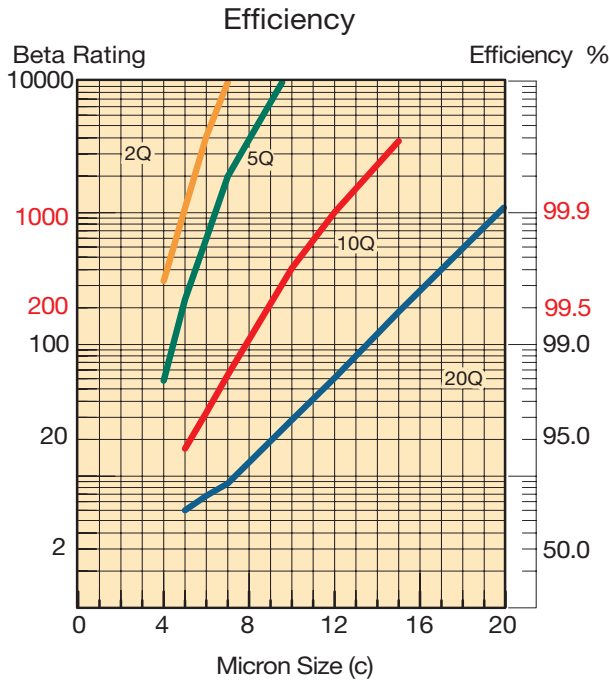

Results typical from Multi-pass tests run per test standard ISO 16889 @ 45 gpm to 100 psid terminal - 10 mg/L BUGL
 Refer to Appendix on pages 264-265 for relationship to test standard ISO 4572.

Flow vs. Pressure Loss

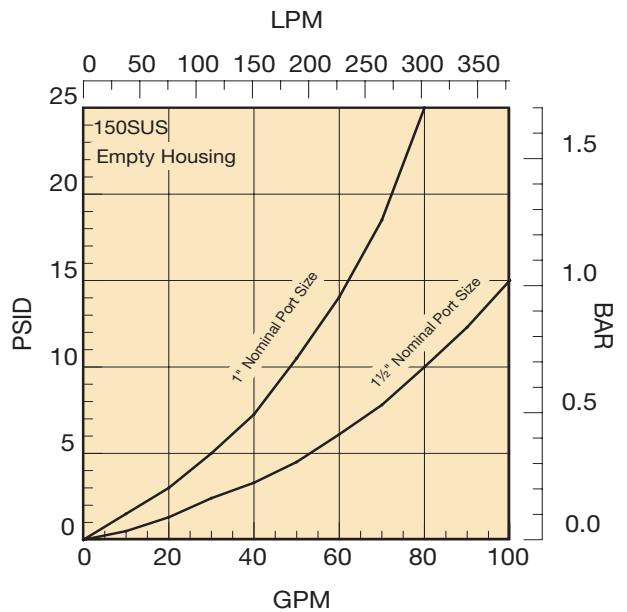
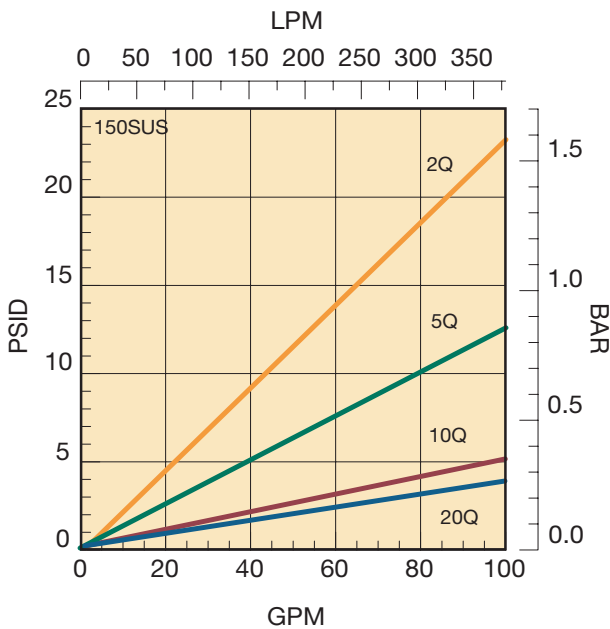

80CN Series

80CN-1 Element Performance

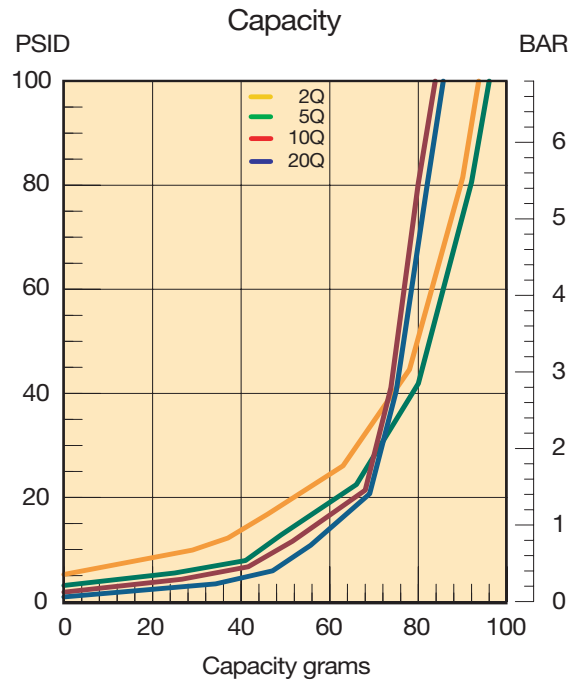
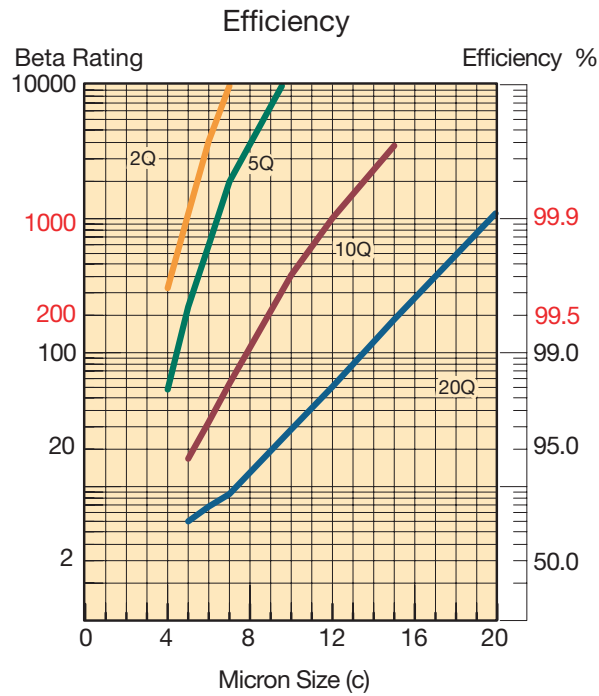

Results typical from Multi-pass tests run per test standard ISO 16889 @ 45 gpm to 100 psid terminal - 10 mg/L BUGL
 Refer to Appendix on pages 264-265 for relationship to test standard ISO 4572.

Flow vs. Pressure Loss

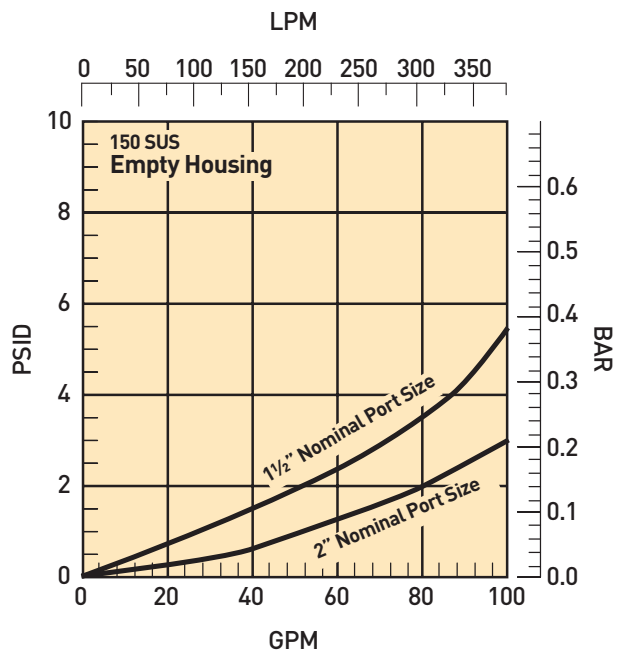
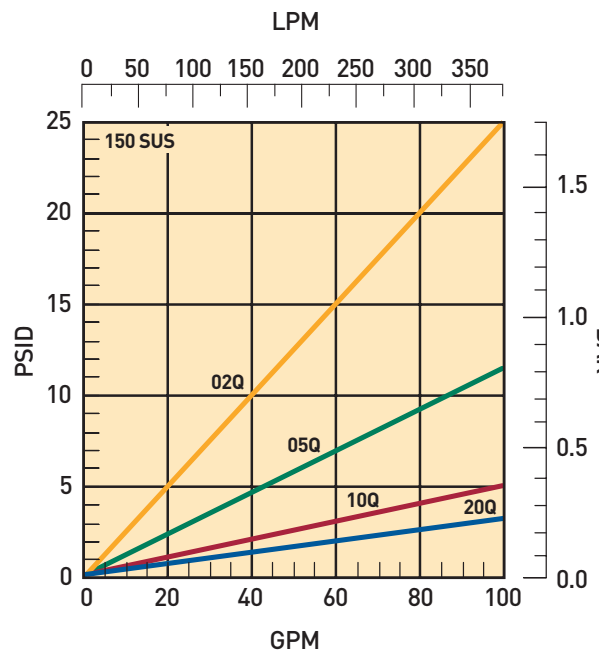

80CN Series

80CN-2 Element Performance

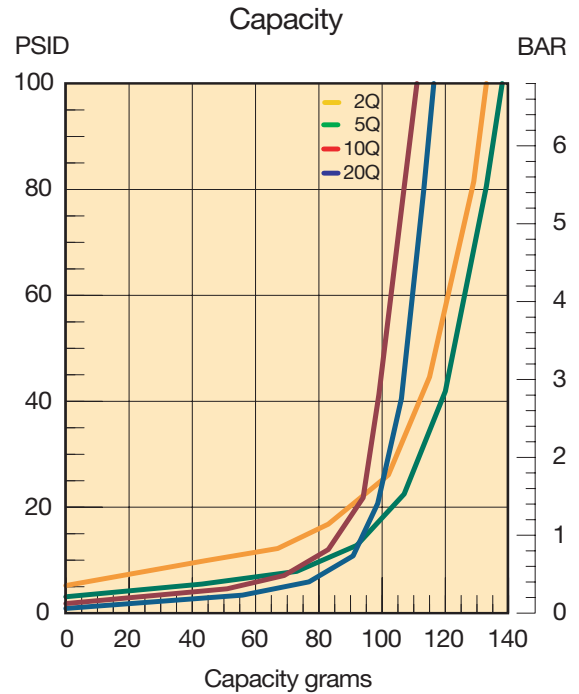
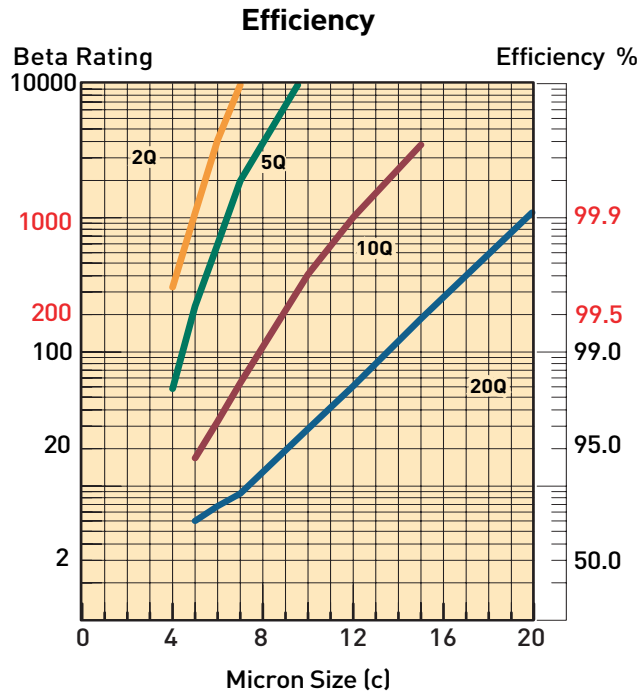

Results typical from Multi-pass tests run per test standard ISO 16889 @ 70 gpm to 100 psid terminal - 10 mg/L BUGL. Refer to Appendix on pages 264-265 for relationship to test standard ISO 4572.

Flow vs. Pressure Loss

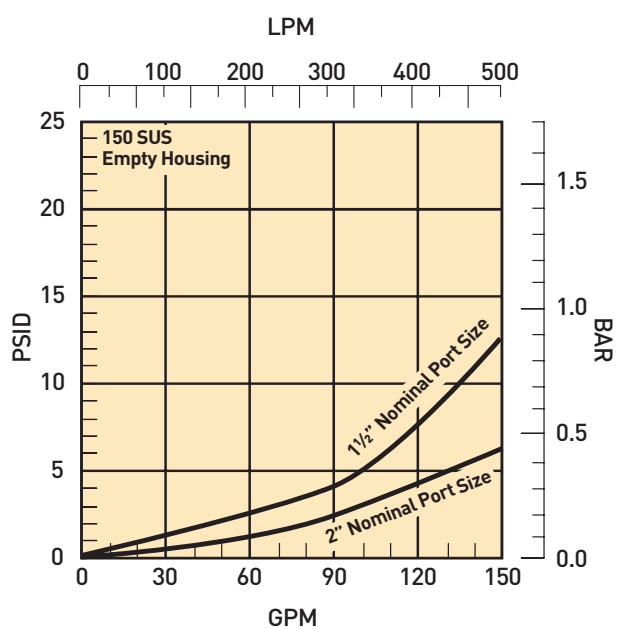
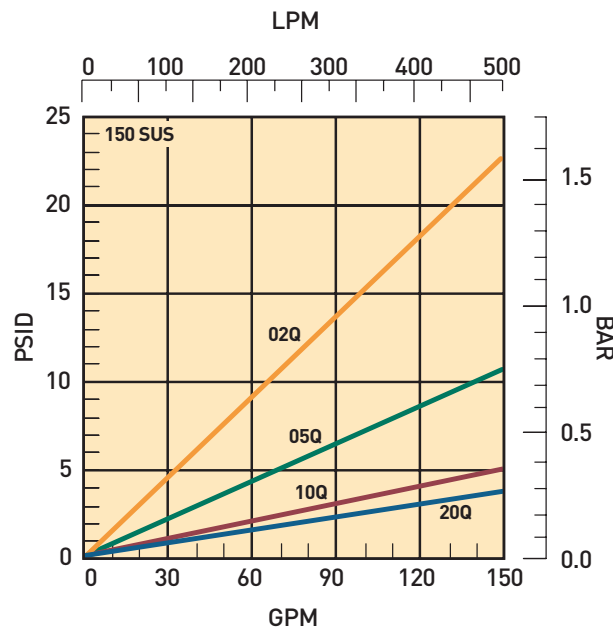

15/40/80CN Series

Specifications

Maximum Allowable Operating Pressure (MAOP):

1000 psi (69 bar)

Rated Fatigue Pressure:

800 psi (55.2 bar)

Design Safety Factor: 2.5:1

Operating Temperatures:

Nitrile: -40°F (-40°C) to 225°F (107°C)

Fluorocarbon: -15°F (-26°C) to 225°F (107°C)

Element Collapse Rating:

Standard: 150 psi (10.3 bar)

Drawings are for reference only.
Contact factory for current version.

Materials:

Head and Bowl: Aluminum

Indicators: Alum. body, plastic connectors

Bypass: Nylon

Weights (approximate):

Model Single length Double length

15CN 2.5 lb. (1.13 kg) 3.5 lb. (1.6 kg)

40CN 4.5 lb. (2.00 kg) 5.5 lb. (2.49 kg)

80CN 12.4 lb. (5.62 kg) 15.2 lb. (6.89 kg)

Element Condition Indicators:

Visual 360° green/red auto reset

Electrical/Visual

5A @ 240VAC, 3A @ 28VDC

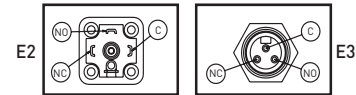

Electrical-Heavy Duty

.25A(resistive) MAX 5 watts

12 to 28 VDC & 110 to 175 VAC

Color code:

White (common)

Black (normally open)

Blue (normally closed)

Dimensions are in (mm)	A	B	C	D	E	F	G	H	I	J	K	L	M
15CN	6.17 (156.6)	9.87 (250.7)	1.83 (46.5)	1.00 (25.4)	2.80 (71.1)	3.38 (85.9)	2.88 (73.2)	3.25 (82.6)	1.50 (38.1)	.90 (22.9)	1.69 (42.9)	1.44 (36.6)	NA
40CN	6.73 (170.8)	10.33 (262.4)	2.44 (62.0)	1.28 (32.6)	4.22 (107.2)	5.00 (127.0)	4.37 (111.0)	4.80 (121.9)	2.44 (62.0)	1.25 (31.8)	2.32 (58.8)	2.37 (60.2)	15.07 (382.8)
80CN	11.06 (280.9)	15.81 (401.6)	3.06 (77.7)	1.95 (49.5)	4.91 (124.8)	6.25 (158.7)	3.25 (82.6)	5.96 (151.4)	4.00 (101.6)	1.62 (41.1)	3.12 (79.4)	1.63 (41.3)	NA

15CN

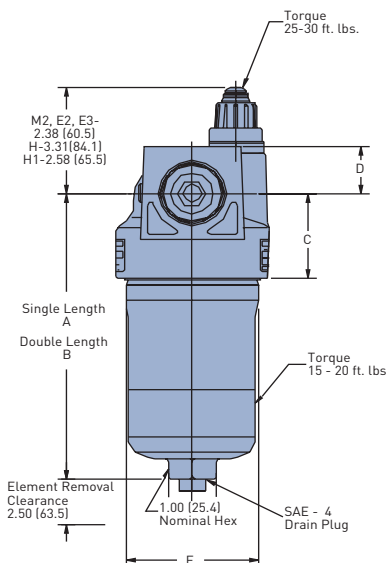
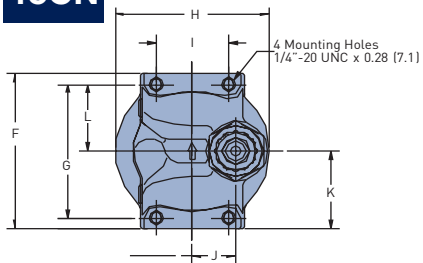

40CN

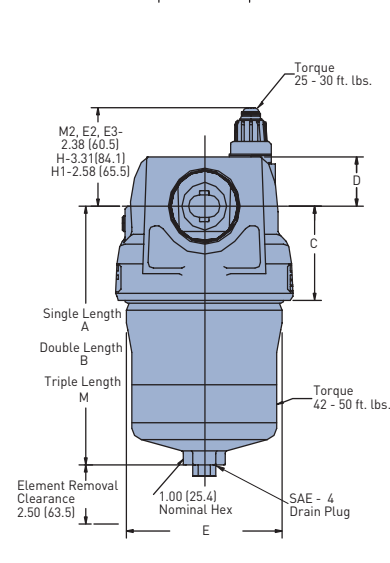
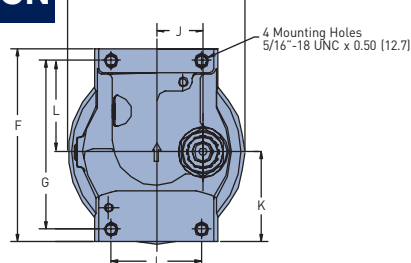

80CN

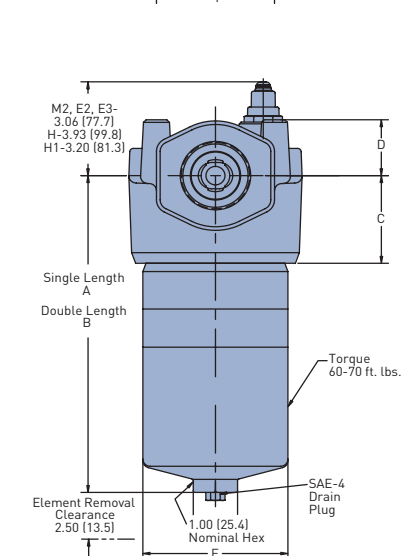
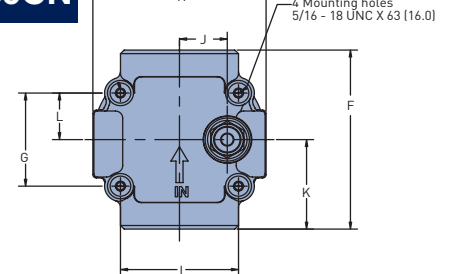

15/40/80CN Series

Element Service Instructions

- A. Stop the system's power unit.
- B. Relieve any system pressure in the filter line.
- C. Drain the filter bowl if drain port option is provided.
- D. Loosen and remove bowl.
- E. Remove element by pulling downward with a slight twisting motion and discard.
- F. Check bowl o-ring for damage and replace if necessary.
- G. Lubricate element o-ring with system fluid and place on post in filter head.
- H. Install bowl and tighten to specified torque.
 - 15CN - 15-20 ft. lbs
 - 40CN - 42-50 ft. lbs
 - 80CN - 60-70 ft. lbs
- I. Confirm there are no leaks after powering the system.

Parts List

Index	Description	15CN	40CN	80CN	
1	Head				
	3/4" NPT bypass/ indicator ready	933865	N/A	N/A	
	3/4" NPT no bypass/ no indicator	933877	N/A	N/A	
	3/4" NPT no bypass/ indicator ready	933869	N/A	N/A	
	3/4" NPT no indicator/ bypass ready	933873	N/A	N/A	
	SAE-12 bypass/ indicator ready	933863	N/A	N/A	
	SAE-12 no bypass/ no indicator	933875	N/A	N/A	
	SAE-12 no bypass/ indicator ready	933867	N/A	N/A	
	SAE-12 no indicator/ bypass ready	933871	N/A	N/A	
	1" NPT bypass/ indicator ready	933864	932950	N/A	
	1" NPT no bypass/ no indicator	933876	932986	N/A	
	1" NPT no bypass/ indicator ready	933868	932962	N/A	
	1" NPT no indicator/ bypass ready	933872	932974	N/A	
	SAE-16 bypass/ indicator ready	933862	932947	N/A	
	SAE-16 no bypass/ no indicator	933874	932983	N/A	
	SAE-16 no bypass/ indicator ready	933866	932959	N/A	
	SAE-16 no indicator/ bypass ready	933870	932971	N/A	
	1 1/2" NPT bypass/ indicator ready	N/A	932948	934012	
	1 1/2" NPT no bypass/ no indicator	N/A	932984	934018	
	1 1/2" NPT no bypass/ indicator ready	N/A	932960	934016	
	1 1/2" NPT no indicator/ bypass ready	N/A	932972	934014	
	SAE-24 bypass/ indicator ready	N/A	932945	934027	
	SAE-24 no bypass/ no indicator	N/A	932981	934033	
	SAE-24 no bypass/ indicator ready	N/A	932957	934031	
	SAE-24 no indicator/ bypass ready	N/A	932969	934029	
	2" NPT bypass/ indicator ready	N/A	N/A	934020	
	2" NPT no bypass/ no indicator	N/A	N/A	934026	
	2" NPT no bypass/ indicator ready	N/A	N/A	934024	
	2" NPT no indicator/ bypass ready	N/A	N/A	934022	
	SAE-32 bypass/ indicator ready	N/A	N/A	934035	
	SAE-32 no bypass/ no indicator	N/A	N/A	934042	
	SAE-32 no bypass/ indicator ready	N/A	N/A	934040	
SAE-32 no indicator/ bypass ready	N/A	N/A	934037		
Flange face, SAE 2" bypass/indicator ready	N/A	N/A	934103		
Flange face, SAE 2" no bypass/no indicator	N/A	N/A	934109		
Flange face, SAE 2" no bypass/indicator ready	N/A	N/A	934107		
Flange face, SAE 2" no indicator/bypass ready	N/A	N/A	934105		
2	Indicators				
	M2-Visual auto reset/ 25 psi	932026	932026	932026	
	M2-Visual auto reset/ 50 psi	932027	932027	932027	
	3	H-Electrical/ 25 psi w/ 1/2" conduit connection	933053	933053	933053
		H-Electrical/ 50 psi w/ 1/2" conduit connection	932905	932905	932905
		H1-Electrical/ 25 psi w/ wire leads	933054	933054	933054
		H1-Electrical/ 50 psi w/ wire leads	932906	932906	932906
	Not Shown:				
	E-Electrical/Visual 25 psi w/ wire leads	929610	929610	929610	
	E-Electrical/Visual 50 psi w/ wire leads	929587	929587	929587	
	4	E2-Electrical/Visual 25 psi w/ DIN connection	931153	931153	931153
		E2-Electrical/Visual 50 psi w/ DIN connection	929599	929599	929599
E3-Electrical/Visual 25 psi w/ 3-pin connection		932773	932773	932773	
E3-Electrical/Visual 50 psi w/ 3-pin connection	929596	929596	929596		
6	Bypass Valve				
	25 psid assembly	928979	930507	933628	
	50 psid assembly	928981	933424	933630	
Not Shown:					
No bypass plug	935744	927719	934174		
Element (see model code page)					
8	Bowl				
	Single length	936758	936760	936763	
	Double length	936759	936761	936764	
	Triple length	-	936762	-	
9	Bowl and Dust Seal				
	Buna N (Nitrile)	N72142	N72239	N72244	
	Fluorocarbon	V72142	V72239	V72244	
10	Drain Plug - SAE-4				
	Buna N (Nitrile)	921088	921088	921088	
	Fluorocarbon	928882	928882	928882	

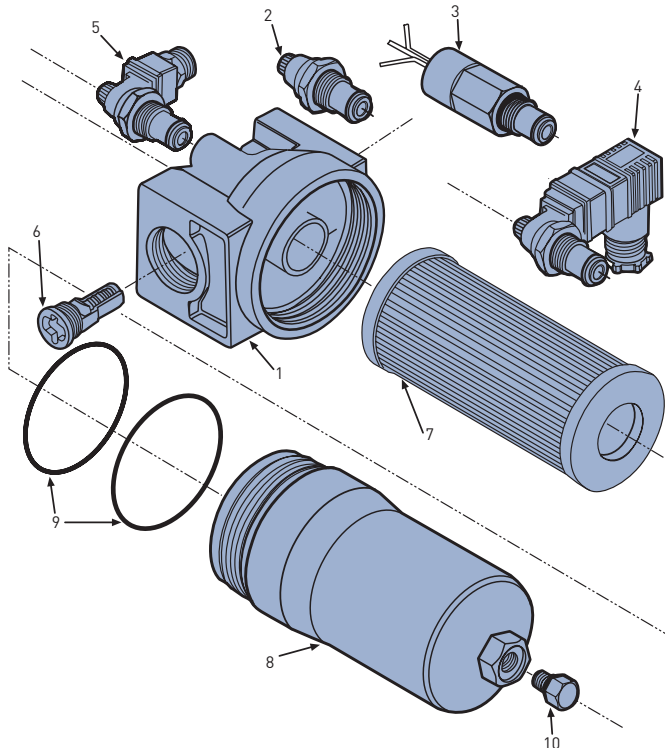

15/40/80 CN Series

How to Order

Select the desired symbol (in the correct position) to construct a model code.

Example:

BOX 1	BOX 2	BOX 3	BOX 4	BOX 5	BOX 6	BOX 7	BOX 8
40CN	1	10QE	B	M2	K	N24	4

BOX 1: Filter Series	
Symbol	Description
15CN	In line Filter
40CN	In line Filter
80CN	In line Filter

BOX 2: Element Length	
Symbol	Description
1	Single
2	Double
3	Triple (40CN only)

BOX 3: Media Code	
Symbol	Description
02QE	Ecoglass III, 2 micron
05QE	Ecoglass III, 5 micron
10QE	Ecoglass III, 10 micron
20QE	Ecoglass III, 20 micron

BOX 4: Seals	
Symbol	Description
B	Nitrile (NBR)
E	Ethylene propylene (EPR)
V	Fluorocarbon (FKM)

BOX 5: Indicator	
Symbol	Description
M2	Visual Automatic Reset
H	Electrical indicator with ½"-14 NPT connection and 12" leads
E	Electrical/Visual with ½" NPT conduit connection and wire leads
E2	Electrical/ Visual (DIN43650 Hirschman style connection)
E3	Electrical/Visual (ANSI B.9355M 3-pin Brad Harrison style connection)
P	Plugged indicator port

BOX 6: Bypass	
Symbol	Pressure Setting
G	25 PSI (1.7 bar)
K	50 PSI (3.5 bar)

BOX 7: Ports	
Symbol	Description
15CN	
N12	¾" NPT
N16	1" NPT
S12	SAE-12 straight thread
S16	SAE-16 straight thread
40CN	
N16	1" NPT
N24	1½" NPT
S16	SAE-16 straight thread
S24	SAE-24 straight thread
80CN	
N24	1½" NPT
N32	2" NPT
S24	SAE-24 straight thread
S32	SAE-32 straight thread
Y32	Flange face, SAE-2", Code 61

BOX 8: Options	
Symbol	Description
4	Standard drain port on bowl
21	No bypass and drain port

Please note the bolded options reflect standard options with a reduced lead-time. Consult factory on all other lead-time options.

Replacement Elements (Ecoglass)

MEDIA	15CN-1	15CN-2	40CN-1	40CN-2	40CN-3	80CN-1	80CN-2
20QE	936701Q	936705Q	936709Q	936712Q	936721Q	936715Q	936719Q
10QE	936700Q	936704Q	936708Q	936601Q	936720Q	936602Q	936718Q
05QE	936699Q	936703Q	936707Q	936711Q	936623Q	936714Q	936717Q
02QE	936698Q	936702Q	936706Q	936710Q	936622Q	936713Q	936716Q

Global products as identified are offered worldwide through all Parker locations and utilize a common ordering code.

